

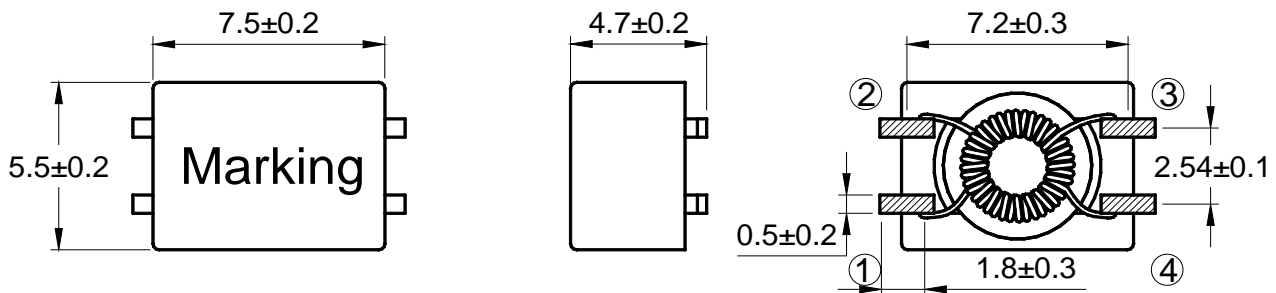

Outline: 产品概要

- Excellent impedance characteristics, making it great for suppressing common mode noise.
高阻抗特性，能高效抑制共模噪音效果。
- Low profile design makes it optimal for surface mounting.
较低的高度设计，适合表面安装。
- Current compensated surface mount common mode chokes for controller area networks (CAN-Bus) in automotive, industrial and medical applications.
用于汽车、工业和医疗应用的控制器局域网(CAN-Bus)的电流补偿表面安装共模扼流圈。
- Operating temperature : -40°C ~ +125°C (Including coil's temperature rise)
工作温度：-40°C~+125°C (包含线圈发热)

1 Appearance and Dimensions (mm) 外形尺寸 (mm)



2 Marking 印字标识

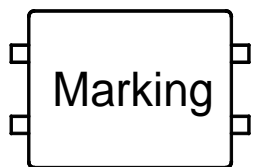

3 Reference Land Pattern (mm) 参考基板尺寸 (mm)

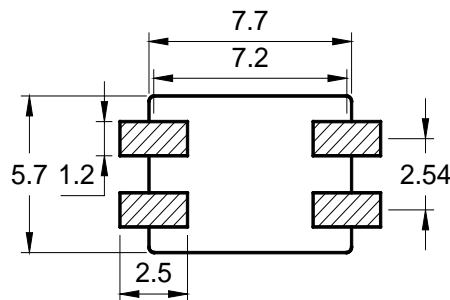

4 Schematic 原理图

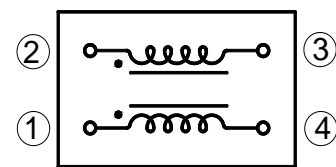

5 Electrical Characteristics

电气特性

Part No. 型号	Inductance (μ H) 电感值	Impedance (Ω) 阻抗值※1	Leakage Inductance (nH) 漏感※2	D.C.R (m Ω) 直流电阻	Rated Current (A) 额定电流※3	Rated Voltage (V) 额定电压	Frequency Range (MHz) 频率范围
		Typical	Typical	Max	Max	Max	
CSTCA0940RB-5R0	5.00 \pm 30%	400	80.0	100	1.20	80.0	500
CSTCA0940RB-110	11.0 \pm 30%	800	100	120	1.00	80.0	200
CSTCA0940RB-250	25.0 \pm 30%	2,000	110	130	0.80	80.0	100
CSTCA0940RS-250	25.0 \pm 30%	2,000	1,400	130	0.80	80.0	100
CSTCA0940RB-510	51.0 \pm 50%	3,800	110	140	0.80	80.0	50.0
CSTCA0940RS-510	51.0 \pm 50%	3,800	2,000	140	0.80	80.0	50.0
CSTCA0940RB-102	1,000 \pm 50%	4,250	200	200	0.70	80.0	7.00
CSTCA0940RB-222	2,200 \pm 50%	5,300	300	400	0.50	80.0	5.00
CSTCA0940RB-472	4,700 \pm 50%	12,300	450	650	0.40	80.0	2.00

■ All data is tested based on 25°C ambient temperature.
所有数据基于环境温度 25°C条件下测试。

※1 Impedance measure condition reference frequency range.
共模阻抗测试条件参考频率范围。

※2 Leakage inductance is for L1 and is measured with L2 shorted.
漏感：在短路 L2 绕组的前提下测试 L1 绕组所得的电感。

※3 Rated current: the value of DC current when the temperature rise is $\Delta T40^{\circ}\text{C}$ ($T_a=25^{\circ}\text{C}$).
额定电流：使产品温度上升到 $\Delta T40^{\circ}\text{C}$ 时所加载的直流电流值($T_a=25^{\circ}\text{C}$)。

※ Special remind: Circuit design, component placement, PCB size and thickness, cooling system and etc. all will affect the product temperature. Please verify the product temperature in the final application.
特别提醒：线路设计，组件布局，印刷线路板(PCB)尺寸及厚度，散热系统等均会影响产品温度。请务必在最终应用时，验证产品发热状况。

**6 Impedance vs Frequency Curve
阻抗值 VS 频率曲线**

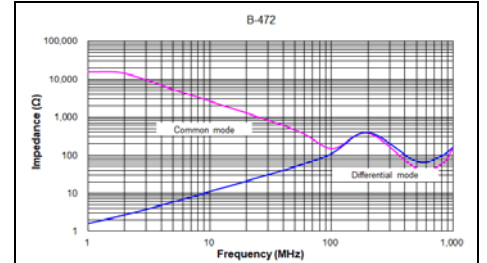
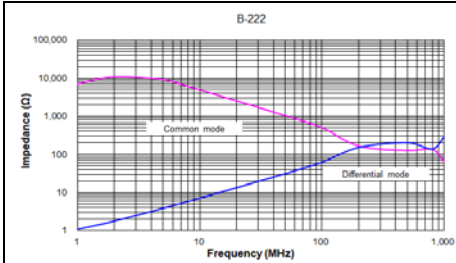
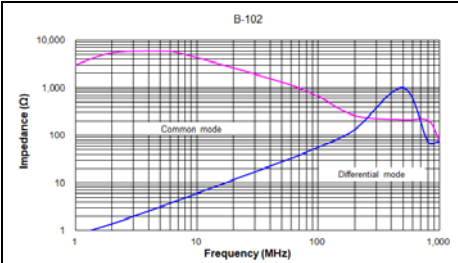
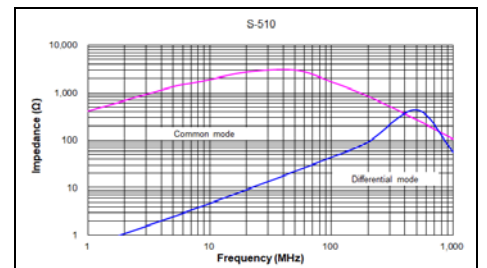
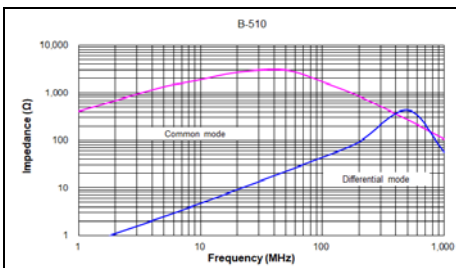
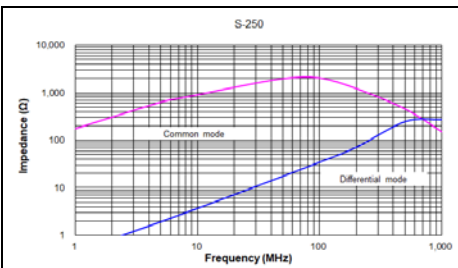
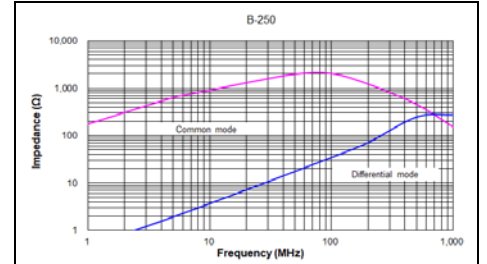
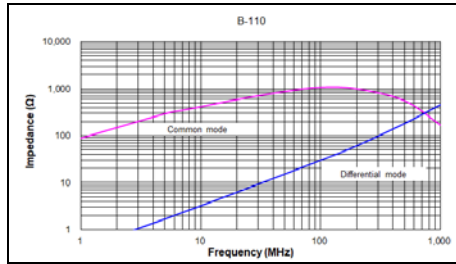
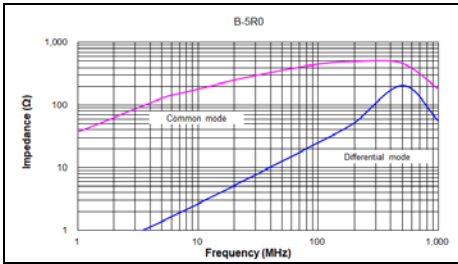

7 Packing Specification

包装规格

7.1 Carrier Tape Dimensions (mm)

载带尺寸

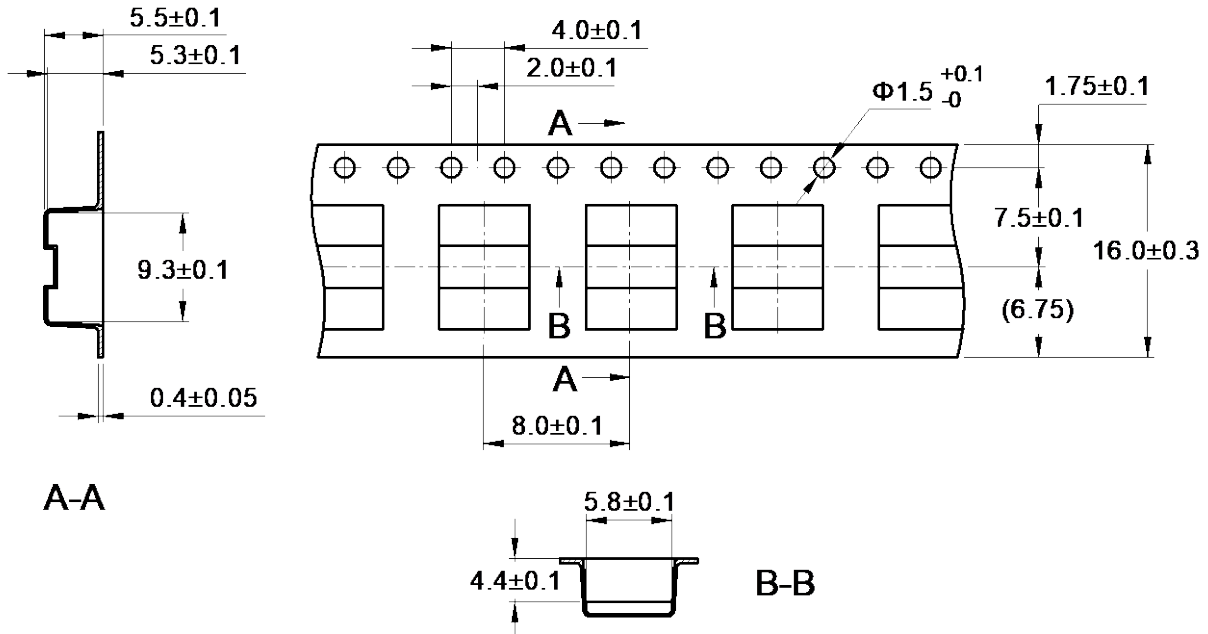

※ Packing is referred to the international standard IEC 60286-3.
包装参照国际标准 IEC 60286-3。

7.2 Tape Direction

捆包方向

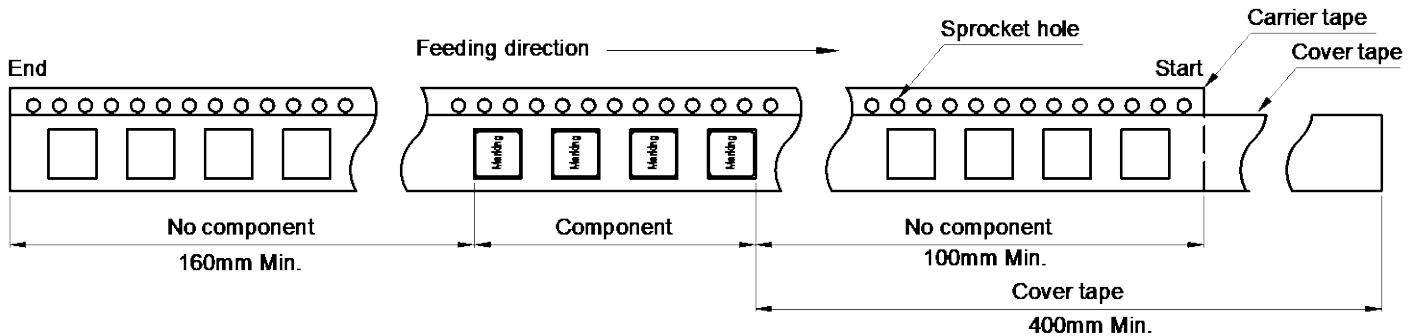

7.3 Cover Tape Peel Off Condition

盖带剥离条件

- Cover tape peel force shall be 0.1 to 1.3N.
盖带剥离力度为 0.1~1.3N。
- Reference peel speed 300±10mm/min.
参考剥离速度 300±10mm/分钟。

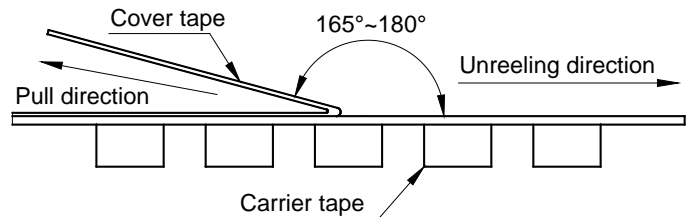

7.4 Reel Dimensions (mm) 卷盘尺寸(mm)

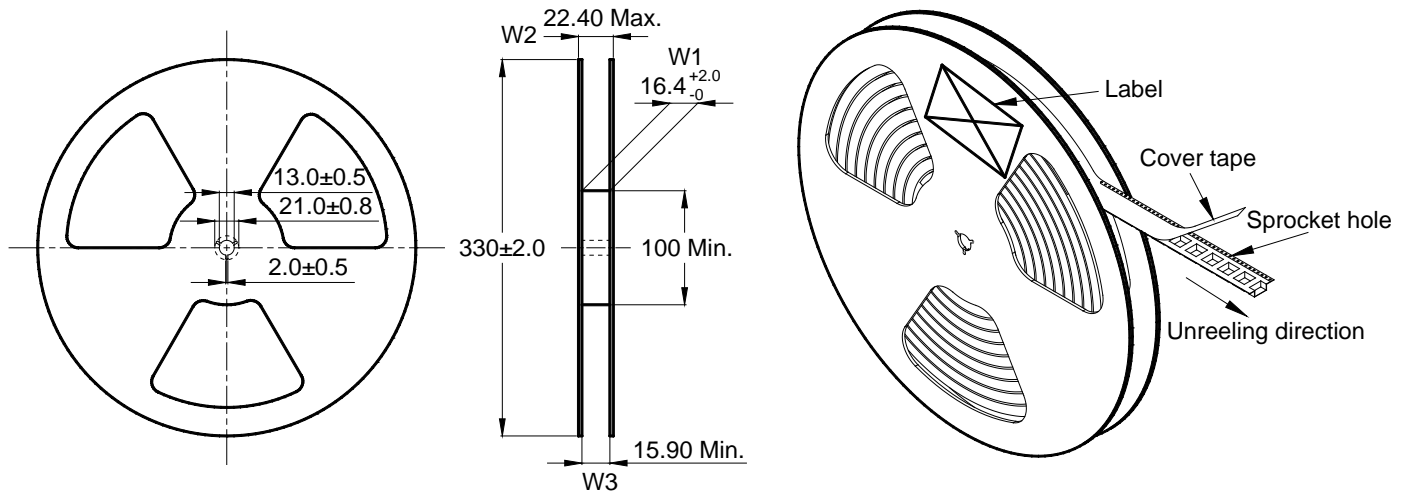

7.5 Carton Dimensions and Packing Quantity 包装箱尺寸和包装数量

■ Inner Carton: 340×340×95mm
内包装盒

■ Out Carton : 355×355×385mm
外包装箱

Product Series 产品系列	Quantity / Reel 数量 / 卷	Inner Carton Quantity 内盒 包装数量	Out Carton Quantity 外箱 包装总数量
CSTCA0940R	1500pcs	(1500×3) = 4500pcs	(4500×3) = 13500pcs

7.6 Label Making 标签标识

The following items will be marked on the tray of product label and shipping label.
以下项目将明确标识于产品吸塑盘标签以及运输标签上。

Production Label 产品标签
■ Packing No. 包装流水号
■ Quantity 数量
■ Shipment Date 出货日期
■ Part No. 产品型号
■ Customer Part No. 客户型号
■ Customer Po No. 客户订单号

Shipping Label 运输标签
■ Packing No. 包装流水号
■ Quantity 数量
■ Shipment Date 出货日期
■ Part No. 产品型号
■ Customer Part No. 客户型号
■ Customer Po No. 客户订单号

8 Soldering Specification

焊接规格

8.1 Reflow Profile for SMT Components

SMT 回流焊温度曲线

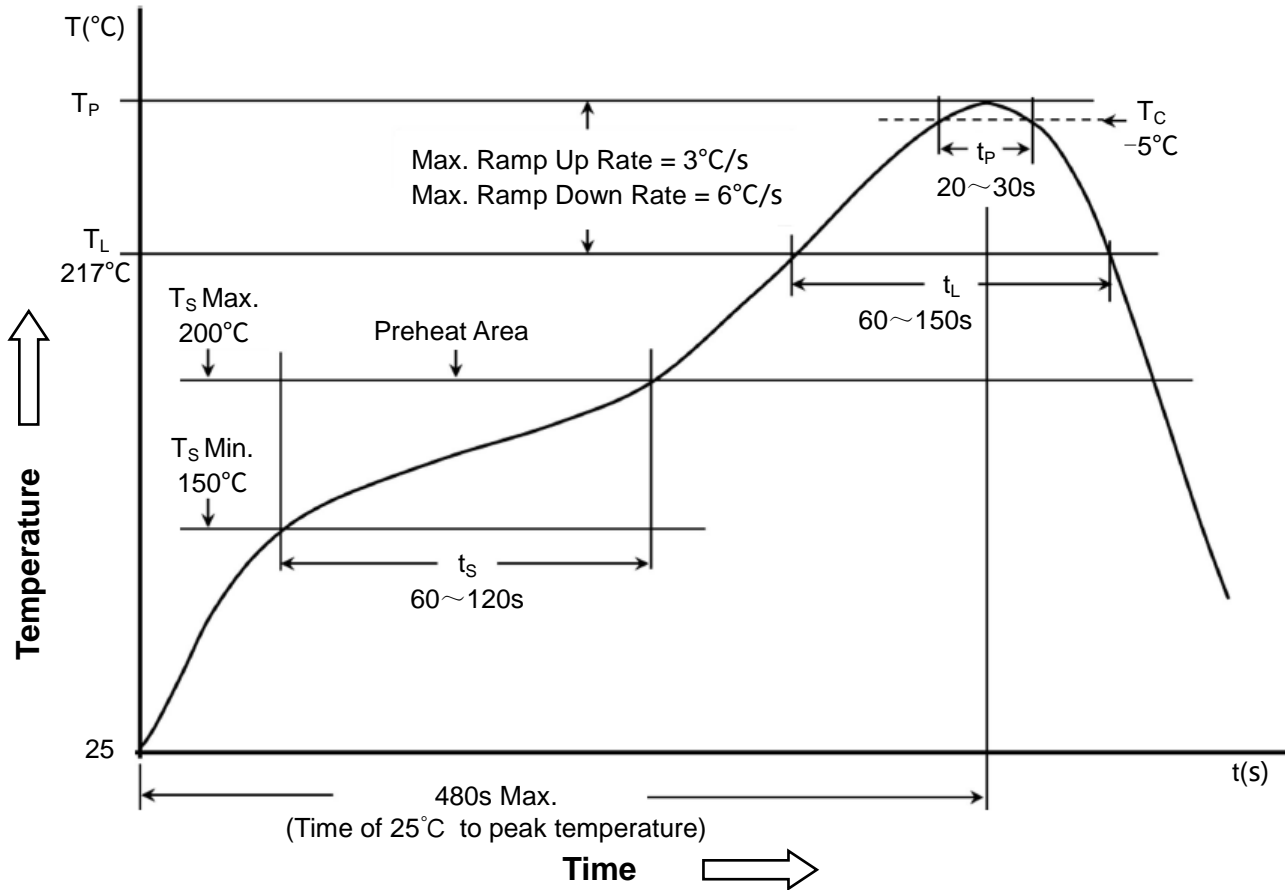

8.2 Classification of Peak Package Body Temperature (Tp)

封装体峰值温度(Tp)分类

	Package Thickness 封装厚度	Package Volume 封装体积		
		<350 mm ³	350~2000 mm ³	>2000 mm ³
PB-Free Assembly 无铅装配	<1.6mm	260°C	260°C	260°C
	1.6~2.5mm	260°C	250°C	245°C
	≥2.5mm	250°C	245°C	245°C

※ Reflow is referred to standard IPC/JEDEC J-STD-020D.
回流焊参照标准 IPC/JEDEC J-STD-020D.

9 Notice of Use**使用注意事项**

9.1 Product in packing storage condition : temperature 5~40°C, RH≤70%.

产品在包装中的保存条件：温度 5~40°C，相对湿度小于等于 70%。

If taking out for use, the remaining products should be sealed in plastic bags and preserved in accordance with the above conditions, to avoid oxidation of terminals (electrodes), affecting soldering status.

如果取出使用，剩余的产品请用胶袋密封按照以上条件保存，避免端子(电极)氧化，影响焊接状态。

9.2 A storage of Codaca Electronic products for longer than 12 months is not recommended, Within other effects, the terminals may suffer degradation, resulting in bad solderability. Therefore, all products shall be used within the period of 12 months based on the day of shipment.

科达嘉电子产品储存期不建议超过 12 个月，在其他影响下，端子可能会退化，导致焊接性差。

因此，所有产品应使用在 12 个月内以出货日为基础。

9.3 Do not keep products in unsuitable storage conditions, such as areas susceptible to high temperatures, high humidity, dust or corrosion.

请不要将产品保存于高温、高湿、有尘埃、腐蚀性气体的不适合环境中。

9.4 Always handle products with care.

请小心轻放，避免由于产品的跌落或取用不当而引致的损坏。

9.5 Don't touch electrodes directly with bare hands as oil secretions may inhibit soldering.

Always ensure optimum conditions for soldering.

手上的油脂会导致可焊性降低，应避免用手直接接触端子。

9.6 When this product will be used on a similar or new project to the original one, sometimes it might be unable to satisfy the specifications due to different condition of usage.

当本产品应用于相似或新的产品上时，电性可能因使用条件的不同而与规格产生一定出入。

9.7 This inductor itself does not have any protective function in abnormal condition, such as overload, short-circuit, open-circuit conditions, etc. Therefore, it shall be confirmed that there is no risk of smoke, fire, dielectric withstand voltage, insulation resistance, etc., or use in abnormal conditions protective devices or protection circuit in the end product.

在过载、短路、开路等不正常条件下，本电感产品无任何自我保护功能。

因此，请确保产品使用中不含烟、火、高压、绝缘等危险使用条件，或使用在不正常条件下的保护作用装置或电路中。

9.8 Hi-Pot test with higher voltage than spec value will damage insulating material and shorten its life.

高电压绝缘测试会对本产品绝缘材料造成损伤，并缩短产品寿命。

9.9 If using in potting compound, the magnet wire coating might be damaged, please consult with us.

如果将本产品用于埋制复合组件，有可能会对本产品的金属线表层造成腐蚀，请咨询本公司。

9.10 Refrain from rinsing coils. If necessary, please consult with us.

请不要清洗产品，如果需要清洗，请咨询本公司。